

SPRUZZO™ K1 PRO

PERFETTO CORNO DESIGN



La Martini

Gorgeous Palette of Colors

The Spruzzo™ K1 PRO packs an unprecedented 160 watts of output into just a 10 inch dia corno design body! Despite its surprisingly small size and unique shape, the Spruzzo pushes out more than enough light to replace conventional wash lights on stage, film sets or commercial architecture.

Sharing the same best in class RGB tri-chip emitters used in Spruzzo's smaller sibling, the Fascio™, a gorgeous palette of saturated, mid-tone and pale tint colors can be dialed in at the touch of a button. And of course, a true white is always available as well, not the unflattering mixed amber compromise found in other lights. The single chip optic eliminates multi-colored shadows and creates a powerful, fully blended color wash wherever the designer needs it.

Smart programming in the Spruzzo™ K1 PRO includes a stand-alone color wash mode and allows multiple units to be easily slaved together, synchronized and off-set using self-generated DMX for color chases and other dynamic lighting patterns without a console. Use it alone, configured in strips & arrays or build it directly into the set or architecture for virtually any application needing colored light, including: stage productions, broadcast studios, bars & casinos, up-scale lobbies and retail stores.

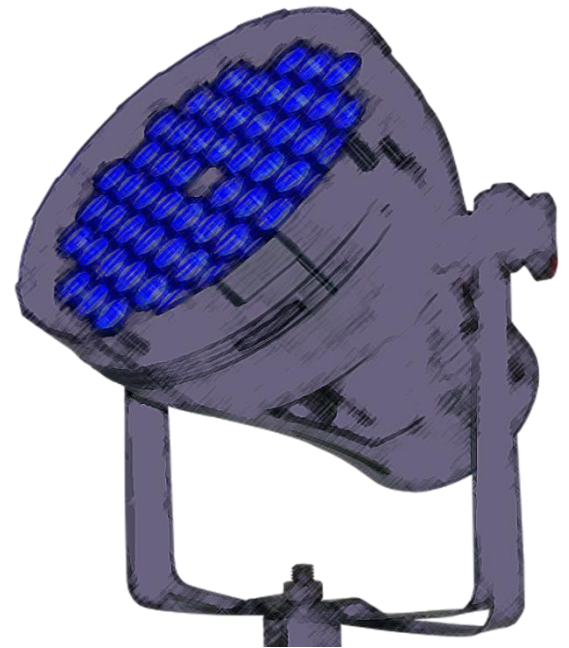

Key Features

- K1 PRO single chip optic casts fringe-free shadows
- Unique patented heat management system packs the most lumens into the smallest form factor
- No expensive power supply or ballasts - direct to mains power 110-240VAC 50/60 Hz
- Multiple luminaires on a single 20A circuit
- Modular design easily configures in strips and arrays for maximum versatility
- Flicker-free dimming 8 bit resolution
- Intuitive full-text interface for manual control
- Easily installed on standard line-voltage lighting track with optional yoke assembly, including full DMX track options
- Full assortment of spot, medium and wide lenses included
- Novel "filament mode" mimics the delayed blackout glow of incandescent fixtures





SPECIFICATIONS

Input Voltage:	110 - 240 VAC 50/60Hz
Power Consumption:	160 Watt at maximum output
LED:	54 x 3W Multi-chip
Beam Angles:	25° Standard. On demand 15° & 45°
Color Range:	16.77 Million Discrete mixes
Power Input:	Neutrik Powercon input and pass-thru
Lumen Maintenance:	80,000 hours B50 L70 at 40C (LM-79-06 Std)
Data:	DMX 3-pin XLR Male, 3-pin XLR Female
Power:	Loop In and Loop Out
Operation:	LED Easy View Display
Operating Temp.:	-22° to 113° F (-30° to 45° C)
Humidity:	0 - 95% non-condensing
Dimensions:	250mm x 265mm x 235mm
Weight:	4.5 lbs (2.04kg)
Housing:	Black Powder Coated Aluminum Body
Mount:	Single or Dual Yoke

CONTROLS

DMX 512 Through 3 Pin XLR
7 Channel DmX Control
Manual Mode Operation
Sound Active Mode Control
Master Slave Mode

APPROVALS

FCC Class A Radiated and Conducted ETL / UL Standards 1573 and 8750 cETL / CSA C22.2#166-M1983
CE / IP20 Rated

SPRUZZO ACCESSORIES

BARNDOOR	515 90100 1056
SAFETY CHAIN	515 90100 2056
C CLAMP	515 90100 2156

All LEDs On

Without Diffuser



Polar Candela Distribution

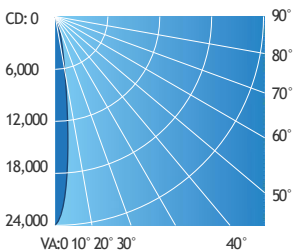

Illuminance at a Distance

Center Beam LUX	Beam Width
0.5m 1,27,306	0.1m
1.0m 31,827	0.2m
1.5m 14,145	0.3m
2.0m 7,956	0.4m
2.5m 5,093	0.5m
3.0m 3,536	0.6m

Beam Spread: 12°

All LEDs On

With 20° Diffuser



Polar Candela Distribution

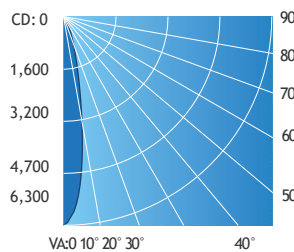

Illuminance at a Distance

Center Beam LUX	Beam Width
0.5m 33,652	0.2m
1.0m 8,414	0.4m
1.5m 3,739	0.6m
2.0m 2,103	0.7m
2.5m 1,346	0.9m
3.0m 935	1.1m

Beam Spread: 21°

All LEDs On

With 40° Diffuser

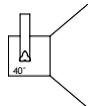

Polar Candela Distribution

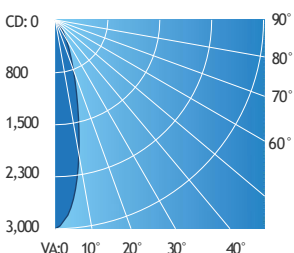

Illuminance at a Distance

Center Beam LUX	Beam Width
0.5m 16,100	0.2m
1.0m 4,025	0.5m
1.5m 1,789	0.7m
2.0m 1,007	0.9m
2.5m 644	1.2m
3.0m 447	1.4m

Beam Spread: 27°

All LEDs On

With 60° Diffuser

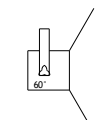

Polar Candela Distribution

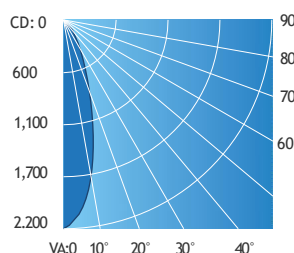

Illuminance at a Distance

Center Beam LUX	Beam Width
0.5m 11,527	0.3m
1.0m 2,882	0.6m
1.5m 1,281	0.9m
2.0m 721	1.2m
2.5m 462	1.4m
3.0m 321	1.7m

Beam Spread: 64°



Environmental and Agency Compliance

1. Luminaire shall be compliant to FCC Class A Radiated and Conducted emissions for commercial and industrial use.
2. Luminaire shall be ETL listed to UL1573 for stage and studio use, and ETL listed to UL8750 for LED equipment used in lighting products.
3. Luminaire shall be CSA Rated C22.2#166-M1983 for LEDs for stage and studio use.
4. Luminaire shall be CE Certified.
5. Luminaire shall be RoHS Compliant.
6. Luminaire shall be rated at IP20 for Indoor use only.

Thermal

1. Luminaire shall operate in an ambient temperature range of -22° F min to 113° F max (-30° C min to 45° C max).

Electrical

1. Luminaire shall be equipped with Neutrik Type adapter and 3-pin DMX adapter.
2. Luminaire shall consume no more than 160w.

LED Emitters

1. Emitters shall be 54 x 3W Multi-chip.
2. Peak color wavelengths/color temperatures shall be: Red – 625nm; Green – 527 nm; Blue – 453 nm; White – 6500K.
3. Lumen Maintenance shall be 80,000 hours B50 L70 at 45C (LM-79-08 Standard).

Control and Dimming

1. Intensity level and color temperature shall be set by DMX control or User Interface (on-board menu). Luminaire shall require 7 channels for control.
2. Luminaire shall be dimmable by DMX control.
3. Dimming shall be flicker-free, 0 – 100%, with dim to warm capability.
4. DMX control shall be achieved with La Martini preset remote or DMX controller.
5. Luminaire shall include DMX Out to enable daisy-chain control of multiple units.
6. Luminaire shall use PWM @ minimum 4kHz for flicker-free dimming.





Safety information.



WARNING!

Read the safety precautions in this manual before installing, operating or servicing this product.

The following symbols are used to identify important safety information on the product and in this manual:



Warning!

***Safety hazard.
Risk of severe
injury or death.***



Warning!

***Powerful light
emission. Risk of
eye injury.***



Warning!

***See user manual
for important
safety information.***



Warning!

***Hazardous voltage.
Risk of lethal or
severe electric shock.***



Warning!

***Hot surfaces
and fire
hazard.***

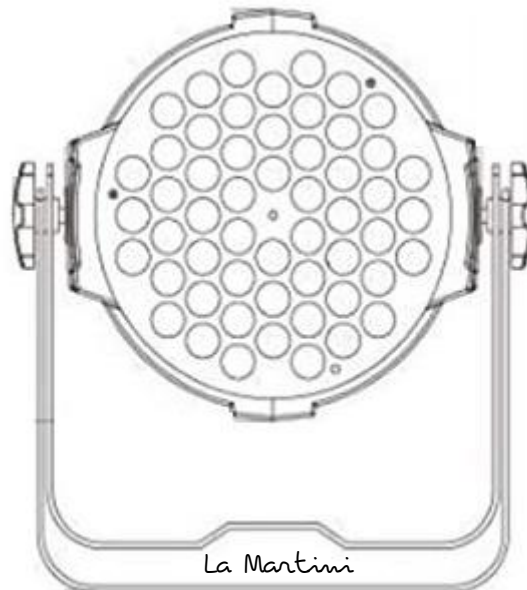

© 2018-2020 La Martini Sarl. Information subject to change without notice. La Martini and all affiliated companies disclaim liability for any injury, damage, direct or indirect loss, consequential or economic loss or any other loss occasioned by the use of, inability to use or reliance on the information contained in this manual. The La Martini logo, the La Martini name, e and all other trademarks in this document pertaining to services or products by La Martini or its affiliates and subsidiaries are trademarks owned or licensed by La Martini or its affiliates or subsidiaries. Citing our continuous Innovations backed by a strong R&D, the particulars mentioned in this document are subject to change without any further notice.